



**Product description**

One-LED Solo™ is a non-maintained, self-contained LED emergency luminaire comprising an Omni-LED emergency LED driver, hinged rechargeable battery and a flush-mount SELV lamp head. Its compact, low-profile hinged design means it can be installed through a 42mm lamp mounting hole, so making it ideal for use fixed ceiling applications.

The LED lamp incorporates a hidden 'push to test' switch and provides constant power output of 1.5W, so maintaining spacing throughout rated duration. The symmetrical distribution of light gives 9.3m spacing from a typical 2.5m height, when using an open area lamp head. For the most efficient spread of light along corridors, an optional corridor lens version is available to provide spacing of 19m from the same height.

**Properties**

- > Optional lensed versions for corridor applications
- > Available with Self-Test and DALI
- > Incorporates NiMH or NiCd cells
- > Built-in charge indicator LED on the lamp head
- > Manually test with a 'push to test' lamp bezel\*
- > Pre-wired for simple installation
- > SELV enclosure incorporating insulated terminals
- > Deep discharge protection (DDP) to protect cells from over discharge
- > Constant current/ constant voltage battery charger
- > Option of mini lamp head for integral mounting
- > Driver complies with: EN61347-1, EN61347-2-7, EN55015, EN61000-3-2, EN61547
- > Luminaire conforms to EN60598-2-22
- > Suitable for installations to EN50172

\* 'Push-To-Test' switch available on recessed ceiling lamp heads only

Technical Data	
Input Supply Voltage	230V +/- 10% - 50/60 Hz
Minimum Emergency Output	188lm Open Area/ 155lm Corridor
Maximum Spacing (2.5m ceiling)	9.3m Open Area/ 19m Corridor
Battery Types	3.6V 1.8Ah NiCd or 2.4V 4Ah 18700 NiMH
Ambient Temperature Range	10-35°C NiMH/ 5-50°C NiCd
Earth Leakage Current	<0.5mA
IP Rating	IP20
Recommended Cut-out Size	42mm
Weight	<90g
Standard Pack Quantities	10

Model Number	Description
OLS/NM3	Articulated Driver, 2 Cell NiMH Battery & Open Area Lamp Head
OLS/3/NM3	Articulated Driver, 3 Cell NiCd Battery & Open Area Lamp Head
OLS/NM3/CL	Articulated Driver, 2 Cell NiMH Battery & Corridor Lens Lamp Head
OLS/3/NM3/CL	Articulated Driver, 3 Cell NiCd Battery & Corridor Lens Lamp Head
OLM/NM3	Articulated Driver, 2 Cell NiMH Battery & Mini Integral Lamp Head



Also available with a 42mm recessed ceiling lamp head with corridor lens or a 27mm diameter mini lamp head for integral mounting.

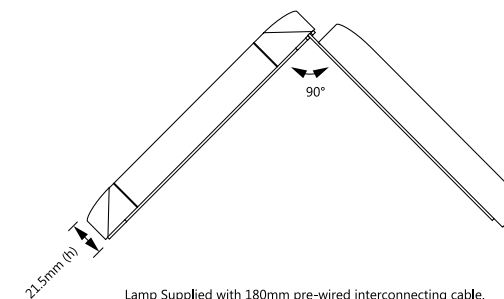
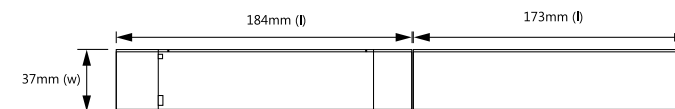

Lamp Supplied with 180mm pre-wired interconnecting cable.

For DALI Self-Test versions add '/DST' to the model numbers above.



TECHNICAL INFORMATION

Model Number	Input Characteristics - Charging Mode			
	Circuit Watts	Input Current	Inrush Current	Power Factor
All	3.5W	30mA	4.5A	0.44

Model Number	Battery & Emergency Output Characteristics							
	Rated Duration	Battery Type	Battery Volts (Range)	Rated Capacity	DDP Voltage	Charge Current	Charging Method	Uout Max (open Circuit)
All	3 hours	NiMH	2 - 2.8V	4Ah	1.8V (min)	0.14 - 0.21 A	Constant Current	12V

Lamp Head Type (All Models)	Mounting Height (Meters)	Distance Table for Even Escape Routes - Based Upon 2m Width of Escape Route					
		Axial/Wall 	Axial/Axial 	Axial/Transverse 	Transverse/Transverse 	Transverse/Wall 	
Open Area	2.00	3.29 m	8.45 m	8.45m	8.62 m	3.48 m	
Corridor Lens		2.14 m	5.76 m	10.97 m	16.72 m	6.97 m	
Open Area	2.50	3.70 m	9.27 m	9.22 m	9.31 m	3.71 m	
Corridor Lens		2.10 m	6.10 m	12.00 m	19.05 m	7.26 m	
Open Area	3.00	3.73 m	10.03 m	9.75 m	10.07 m	3.85 m	
Corridor Lens		2.02 m	6.04 m	12.69 m	20.17 m	7.07 m	
Open Area	3.50	3.77 m	10.56 m	10.35 m	10.46 m	3.93 m	
Corridor Lens		1.78 m	6.01 m	12.47 m	20.73 m	6.31 m	

This Spacing Table is based upon the following parameters:

- > Maintenance factor: 0.9
- > Ballast lumen factor: 1.00
- > Minimum illuminance on centre line: 1 LUX
- > Minimum illuminance on half of escape route width: 0.5 LUX
- > Diversity on the centre line maximum 40:1

Please be aware that these are a minimum guide in accordance with BS/EN 1838. Local risk assessment by a competent person should be carried to ensure the emergency lighting system meets the requirements of the building and its occupants. Photometric data files relating to both open area and corridor lamp heads can be obtained by visiting the download section of [www.one-lux.com/products/one-led-solo/](http://www.one-lux.com/products/one-led-solo/).

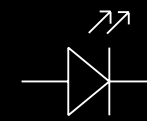

**INSTALLATION** (Standard luminaires. See page 4 for '/DST' DALI Self-test versions.)

**Disclaimers**

This is a dedicated, non- maintained emergency luminaire, so by design the main LED light will only operate upon mains supply failure; it cannot be operated as a standard light source.

This product and its associated accessories have been designed and manufactured to comply with the requirements of EN60598-2-22 and required additional standards. Operation beyond the parameters specified in this document and the associated standards may result in reduced performance and ultimate premature failure, with the warranty made void. The specifier should be aware of the environment to which this luminaire and components are used and adhere to its specifications. Please contact our Technical department if you are in any doubt.

**Precautions**

This luminaire must be installed by a qualified and competent electrician. It should not be mounted in an external location or in areas where temperatures below 10°C may be frequent in cold months and likewise, do not use the luminaire in a hot environment where the temperature is maintained at 35°C or above. In either case, the battery's design life of 4 years will be compromised and provision of three hour emergency duration may not be possible when needed.

**Installation notes**

Prepare supply cables with a strip length of 6mm (10mm maximum). Min/max Conductor sizes: 0.2 - 1.5 mm<sup>2</sup>.

One-LED SOLO must be installed in accordance with the current wiring and building regulations.

It is recommended that a 42mm diameter hole is provided to insert the recessed ceiling lamp head and luminaire. The mains connections should be made to the 3-pole grey terminals marked 'LIVE', 'EARTH' and 'NEUTRAL'. Please note the cable size range for the terminal block is 0.2mm<sup>2</sup> - 1.5mm<sup>2</sup>. This product requires a permanent supply (via test key switch where required) as per the wiring illustration on page 1. Restrain and protect the terminations by affixing the cord restraint and terminal cover provided.

**Commissioning**

Once the luminaires are installed, the mains supply should be instated and remain un-interrupted for a minimum of 24 hours. The supply should then be removed and all luminaires checked for a minimum of 3-hours duration. The label on the battery box must be initialled and dated by the commissioning engineer. See page 4 for Self-test DALI versions.

**Testing**

Regular testing must be carried out and recorded in accordance with BS EN 50172. To facilitate monthly checks, a discrete green charge indicator and manual push-to-test feature are incorporated into One-LED SOLO. Depressing the facia at the point shown in the illustration will operate the lamp in the emergency mode for as long as it is pressed. This feature allows regular testing to be carried out with minimal inconvenience to the building occupants. Please take care to avoid looking directly at the LED when under test. Finger contact with the power LED should also be avoided. For commissioning and the annual full-rated duration test, it is recommended that the supply is isolated via conventional methods such as isolation of the circuit at the MCB or via key test.

Wiring illustration

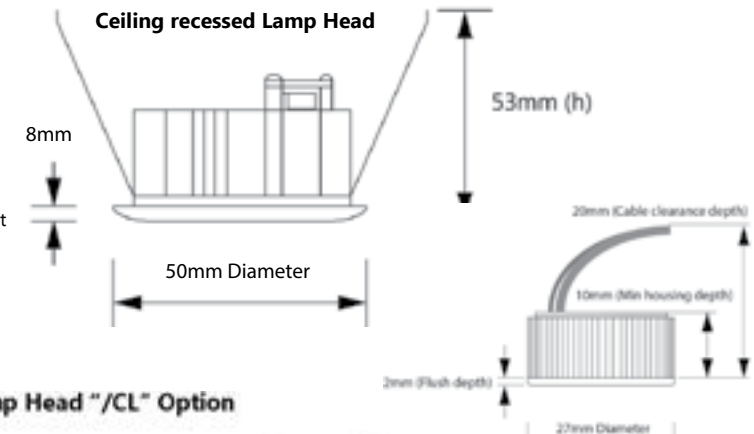
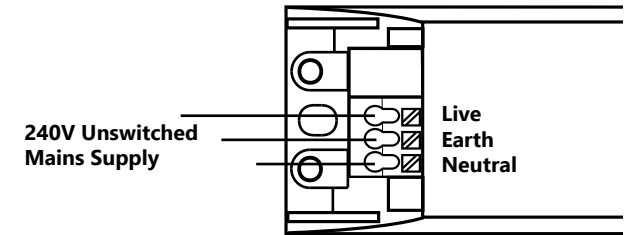

**Open Area Lamp Head Option**

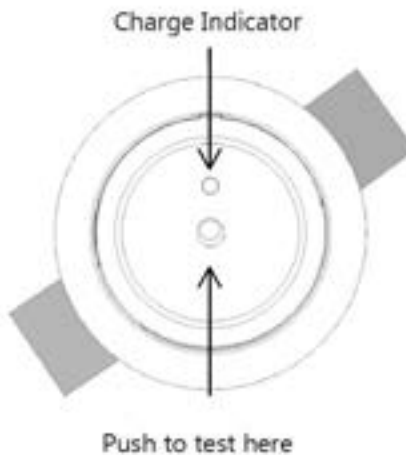

**Corridor Lens Lamp Head "/CL" Option**

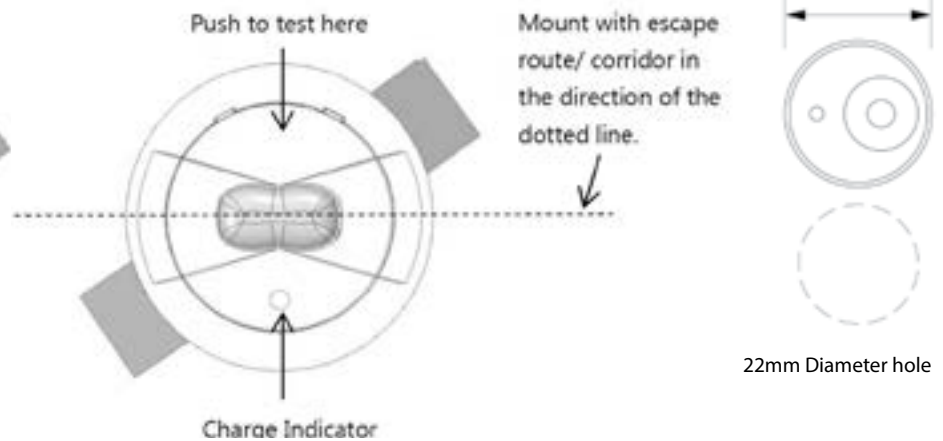

22mm Diameter hole

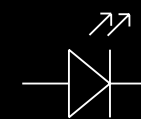

## INSTALLATION & OPERATION of '/DST' DALI Self-test versions

### Commissioning:

Once the luminaire has been installed and availability of the un-switched supply is deemed stable, **connect the battery, then apply mains power to begin the commissioning process.**

After applying power, the One-LED Solo™ will stay in commissioning mode for a minimum of 48 hours + the Duration Test period. The first 24 hours is to fully charge the battery before its Duration Test and second 24 hours to recharge the battery for normal use.

If it is anticipated that the un-switched supply may be interrupted before normal use, we advise that the battery is left disconnected and commissioning is delayed until the supply is stable.

If the luminaire has been stored for a number of months, it may be necessary to repeat the initial charge/discharge process several times to re-condition the battery and achieve full rated emergency duration.

After successful commissioning, the battery should be marked with the date of commission.

### Automatic Testing

Once commissioned, the One-LED Solo™ will automatically determine if it is being used in Standalone Self-Test mode or connected to a DALI network.

If Standalone Self-Test is detected, it will establish randomised delay times to ensure the next scheduled tests do not coincide with the same test of adjacent luminaires. (See table below for details of 'Test Delay Time' ranges). Subsequent routine testing will then take place according to the 'Test Interval' times detailed in the table below.

If the One-LED Solo™ module detects it is installed on a DALI network, it will configure itself according to the default DALI specification. (See table below).

**It is important to note that in DALI mode, randomisation will not be set and it will await test delay times to be configured by the DALI master.**

In the event of loss of communication with the DALI master, automatic testing will revert back to the Self-Test 'Test Intervals', but 'Test Delay Times' will remain as configured by the DALI master.

A One-LED Solo™ can be returned to standalone self test at any time by disconnecting it from the DALI network and forcing a Function Test from the test switch or by cycling the un-switched mains supply. (See page 5 for details).

To fully reset all test times, disconnect the mains, battery power and DALI connections. Once power is restored, the commissioning cycle and randomisation process will be re-initiated.

Short discharge periods each month for the Function Test will not adversely affect One-LUX batteries and should be considered as a maintenance exercise for the battery. Regular full discharge cycles will however adversely affect the design life of the battery, so excessive testing should be avoided wherever possible.

A full summary of automatic test timings can be seen in the table below.

The status of the One-LED Solo™ can be determined at any time from the indicator LED. Details of the indicator LED status conditions and integral test switch functionality can be found on page 5.

Automatic Testing Information					
Test Type	Mode	Duration	Test Delay time	Test Interval / Occurrence	Notes
Commissioning Test	Self-Test	1 or 3 Hours*	24 Hours	Once*	The luminaire will carry out a Duration Test 24 hours after initial power up. *This test cycle will be repeated if un-successfull
	DALI	1 or 3 Hours*	24 Hours	Once*	The luminaire will carry out a Duration Test 24 hours after initial power up. *This test cycle will be repeated if un-successfull
Function Test	Self-Test	1 Minute	1-15 Days	Every 28 Days	-
	DALI	1 Minute	0	Every 7 Days	Caution! Factory default of zero test delay time is set for DALI Mode
Duration Test	Self-Test	1 or 3 Hours*	1-51 Weeks	Every 51 Weeks	-
	DALI	1 or 3 Hours*	0	Every 52 Weeks	Caution! Factory default of zero test delay time is set for DALI Mode

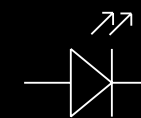

INSTALLATION & OPERATION of '/DST' DALI Self-test versions. Continued.

Luminaire Status Information								
LED Colour	LED Status	On Time (Seconds)		Off Time (Seconds)		Sounder Activated	Purpose	Action required
Green	Very Slow Flash	10		0.5		-	Normal status with fully charged battery (Commissioned unit)	None - In standby mode and operating as normal
	Slow Flash	1.5		0.5		-	First 24 hour charge and Duration Test. (Non-Commissioned unit)	None - Await commissioning process to complete
	Fast Flash	0.5		0.5		-	Function Test or Duration Test in progress. (Commissioned unit)	None - Await current test to complete
Varied		On	Off	On	Off		Purpose	Action required
Green	Long 'On' then flash	10	0.5	0.5	0.5	-	Battery being charged (Commissioned unit)	None - Await battery to charge (Normally 24 Hours)
	Long 'Off' then flash	0.5	10	0.5	0.5	-	Second battery charge after Commissioning Duration Test	None - Await battery to charge (Normally 24 Hours)
Red & Green (alternate)	Fast Flash	0.5	0.5	0.5	0.5	-	Physical select enabled by DALI system only	Confirm Physical select with optional Test Switch

Luminaire Status Information (Fault Conditions)								
LED Colour	LED Status	On Time (Seconds)		Off Time (Seconds)		Sounder Activated	Purpose	Action required
Red	Slow Flash	0.5		1.5		Yes	Battery fault	Check battery & connections, repair/ replace as necessary
	Fast Flash	0.5		0.5		Yes	Lamp or internal circuit fault	Check Lamp & connections, repair/ replace as necessary

Test Switch Information	
Function	Test Switch Action
Disable Sounder	Press and hold for longer than 5 seconds (Sounder bleeps once for confirmation)
Enable Sounder	Press and hold for longer than 5 seconds (Sounder bleeps twice for confirmation)
Start a Function Test	Press and release 2 times within 5 seconds
Confirm physical selection	Press once during physical selection mode initiated by DALI system