

Product description

Omni-LED-LFP™ is a range of Maintained emergency lighting conversion modules for use with One-LUX LiFePO4 batteries.

They are housed in a compact low-profile enclosure and suitable for use in either internal or remote self-contained applications.

Their constant-power emergency driver technology with a SELV isolated output will run almost any LED lamp or array in the range of 10V – 230VDC including many GU10 and Linear tubes, so making it easy to produce an emergency version of your existing LED luminaire without the need for separate ‘emergency’ LEDs or connectors. They are available with 2W to 12W of emergency power and for 1 or 3 hour autonomy.

Features

- > Wide range of lamp voltage and power options available
- > 3-pole switching provides full isolation of lamp connections and mains driver’s power supply during emergency operation
- > Universal module with user-selectable 1 or 3 hour autonomy
- > Also available with Self-Test and DALI
- > Constant-current charger with short-circuit protection and polarised battery socket
- > Batteries include voltage, current and thermal protection
- > Input for optional manual low-voltage emergency test switch
- > Additional side fixing points allows mounting in restricted spaces
- > Operates High-brightness green charge LEDs. (250mm supplied. Other lengths available on request.
- > Designed and manufactured in Great Britain
- > Complies with: EN61347-1, EN61347-2-7, EN61347-2-13, EN55015, EN61000-3-2, EN61547
- > Suitable for luminaires conforming to EN60598-2-22

Common Technical Data	
Input Supply Voltage	230V +/- 10%
Supply Frequency	50/60 Hz
Output Voltage of the Range	10 - 230Vdc
Operating Ambient Temperature	0°C - 50°C
Battery Charge Time	<24 Hours
IP Rating	IP20
Omni-LED Module Weight	90g



LED Voltage	Emergency Power	Omni-LED Module	LiFePO4 Battery	Battery End Caps*	Kit Code
12 - 55V	3W	OL55/3W/M3/LFP	LFP/3.2V/4.4Ah/SS	E/SUB-C	OL55/3W/M3/LFP/SS
			LFP/3.2V/4.4Ah/PS	N/A	OL55/3W/M3/LFP/PS
			LFP/3.2V/4.5Ah/SS	E/18700	OL55/3W/M3/LFP/3SS
			LFP/3.2V/2.2Ah/SC	E/SUB-C	OL55/3W/M1/LFP/SC
12 - 55V	4W	OL55/4W/M3/LFP	LFP/6.4V/3.6Ah/SS	E/26650	OL55/4W/M3/LFP/SS
			LFP/6.4V/2.2Ah/SS	E/SUB-C	OL55/4W/M1/LFP/SS
6 - 80V	2W	OL80/2W/M3/LFP	LFP/3.2V/3.6Ah/SC	E/26650	OL80/2W/M3/LFP/SC
			LFP/3.2V/2.2Ah/SC	E/SUB-C	OL80/2W/M1/LFP/SC
55 - 90V	4W	OL90/4W/M3/LFP	LFP/6.4V/3.6Ah/SS	E/26650	OL90/4W/M3/LFP/SS
			LFP/6.4V/2.2Ah/SS	E/SUB-C	OL90/4W/M1/LFP/SS
90 - 200V	4W	OL200/4W/M3/LFP	LFP/6.4V/3.6Ah/SS	E/26650	OL200/4W/M3/LFP/SS
			LFP/6.4V/2.2Ah/SS	E/SUB-C	OL200/4W/M1/LFP/SS
110 - 230V	4W	OL230/4W/M3/LFP	LFP/9.6V/2.2Ah/SS	E/SUB-C	OL230/4W/M3/LFP/SS
			LFP/9.6V/1.5Ah/SS	E/18700	OL230/4W/M1/LFP/3SS
110 - 230V	8W	OL230/8W/M3/LFP	LFP/9.6V/3.6Ah/SS	N/A	N/A - RBC & RBF Format Only
		OL230/8W/M1/LFP	LFP/9.6V/2.2Ah/SS		
110 - 230V	12W	OL230/12W/M3/LFP	LFP/9.6V/6Ah/QS	N/A	N/A - RBC & RBF Format Only
		OL230/12W/M1/LFP	LFP/9.6V/3.6Ah/SS		

Document under development and product specifications may be subject to change without prior notice.

For DALI Self-Test versions add '/DST' to the product codes above. /DST' not yet available for OL230V versions



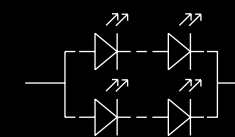

TECHNICAL INFORMATION

Model Number	Mains Input Characteristics - Charging Mode				
	Autonomy Setting	Nominal Circuit Watts*	Input Current	Inrush Current	Power Factor
OL55/3W/M3/LFP	1 hour	2.5W	10-40mA (25.5mA)	4A pk	0.57
	3 hours	3.5W	10-40mA (25.5mA)	4A pk	0.57
OL80/2W/M3/LFP	1 hour	2.0W	10-40mA (25.5mA)	4A pk	0.57
	3 hours	2.5W	10-40mA (25.5mA)	4A pk	0.57
OL55/4W/M3/LFP, OL90/4W/M3/LFP OL200/4W/M3/LFP	1 hour	3.5W	10-40mA (33mA)	6.5A pk	0.69
	3 hours	5.5W	10-40mA (33mA)	6.5A pk	0.69
OL230/4W/M3/LFP	1 hour	3.5W	10-40mA (33mA)	6.5A pk	0.69
	3 hours	5.5W	10-40mA (33mA)	6.5A pk	0.69
OL230/8W/M3/LFP	1 hour	3.5W	10-45mA (32mA)	8.2A pk	0.66
	3 hours	5.0W	10-45mA (32mA)	8.2A pk	0.66
OL230/12W/M3/LFP	1 hour	3.5W	10-47.5mA (37.5mA)	8.5A pk	0.70
	3 hours	6.0W	10-47.5mA (37.5mA)	8.5A pk	0.70

* This figure may be used for LENI 'Parastic Power' calculations.

Model Number	Emergency Mode								
	Nominal Battery Capacity (1 hour/ 3 hours)	Battery Volts Range (Charge Mode)	Battery Charge Current Range	Battery Volts Range Min/ Nom/ Max (Discharge Mode)	Battery Discharge Current Nominal/ Range	DDP Voltage	LED Voltage Range	Max Output Power **	Uout Max (open Circuit)
OL55/3W/M3/LFP	2.2Ah/ 4.4Ah	2 - 8V	0 -220mA	2V/ 3.2V/ 3.6V	1.05A /(0.8 - 1.2A)	2.8V (min)	12 - 55V	3W	80V
OL55/4W/M3/LFP	2.2Ah/ 3.6Ah	4 - 10V	0 -210mA	4V/ 6.4V/ 7.2V	1.05A /(0.8 - 1.2A)	6.0V (min)	12 - 55V	4W	80V
OL80/2W/M3/LFP	2.2Ah/ 3.6Ah	2 - 8V	0 -210mA	2V/ 3.2V/ 3.6V	1.05A /(0.8 - 1.2A)	3.0V (min)	6 - 80V	2W	100V
OL90/4W/M3/LFP	2.2Ah/ 3.6Ah	4 - 10V	0 -210mA	4V/ 6.4V/ 7.2V	1.05A /(0.8 - 1.2A)	6.0V (min)	55 - 90V	4W	100V
OL200/4W/M3/LFP	2.2Ah/ 3.6Ah	4 - 10V	0 -210mA	4V/ 6.4V/ 7.2V	1.05A /(0.8 - 1.2A)	6.0V (min)	90 - 200V	4W	260V
OL230/4W/M3/LFP	1.5Ah/ 2.2Ah	6 - 11V	0 -220mA	6V/ 9.6V/ 10.8V	0.5A /(0.45 - 0.55A)	8.0V (min)	110 - 230V	4W	260V
OL230/8W/M3/LFP	2.2Ah/ 3.6Ah	6 - 11V	0 -220mA	6V/ 9.6V/ 10.8V	0.9A /(0.85-0.95A)	8.0V (min)	110 - 230V	8W	260V
OL230/12W/M3/LFP	3.6Ah/ 6.0Ah	6 - 11V	0 -365mA	6V/ 9.6V/ 10.8V	1.05A /(0.8 - 1.2A)	8.0V (min)	110 - 230V	12W	260V

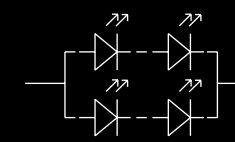

TECHNICAL INFORMATION

LED lamp output - Shaded area indicates typical forward voltage (Vf) vs forward current (If) expected throughout discharge duration.

OL55/3W (&/DST)

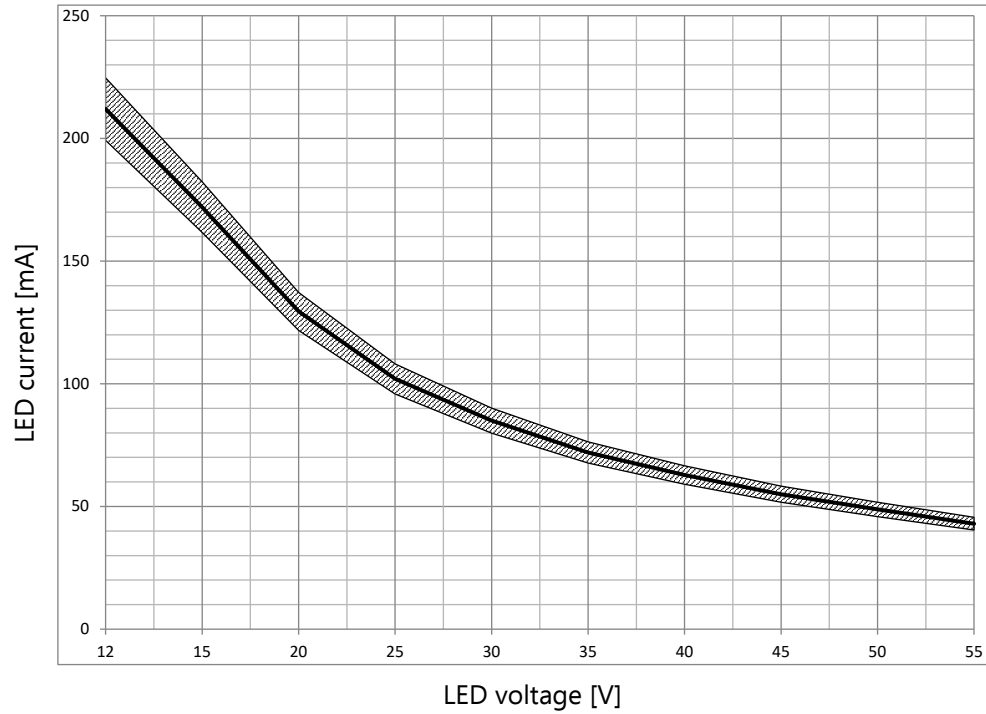

OL55/4W (&/DST)

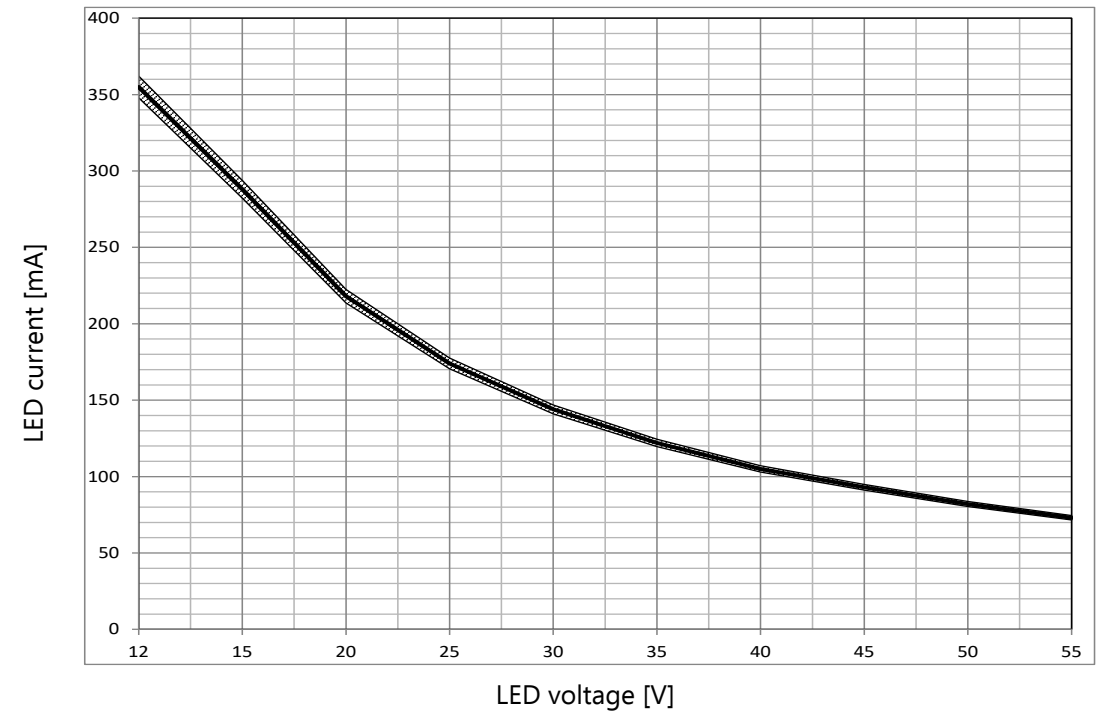

Document under development and product specifications may be subject to change without prior notice.

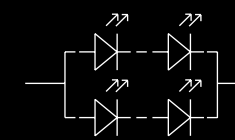

TECHNICAL INFORMATION

LED lamp output - Continued.

OL90/4W (&/DST)

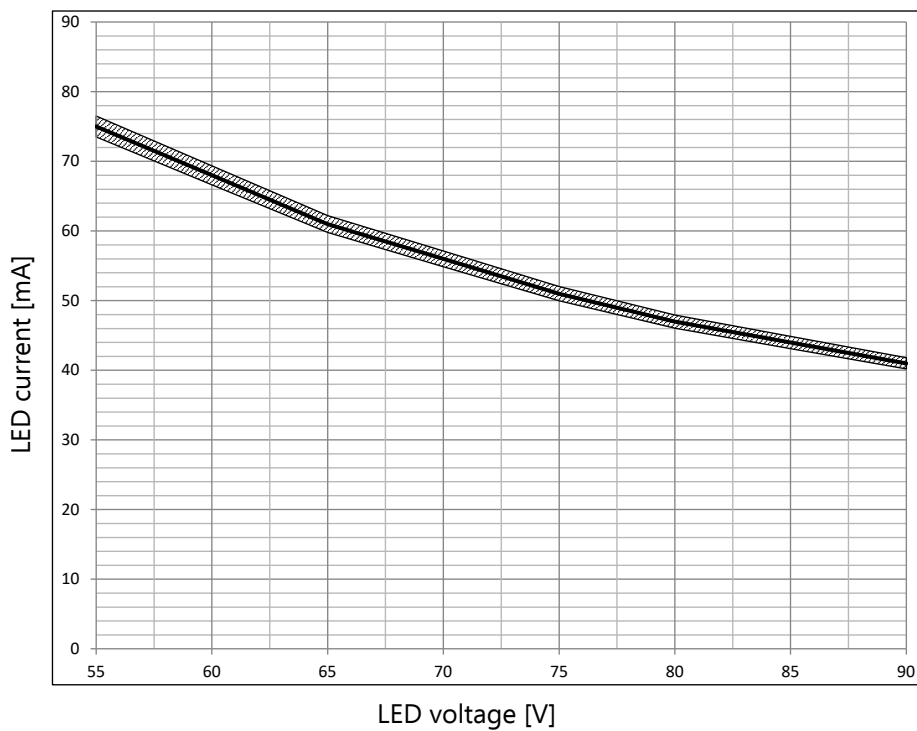

OL200/4W (&/DST)

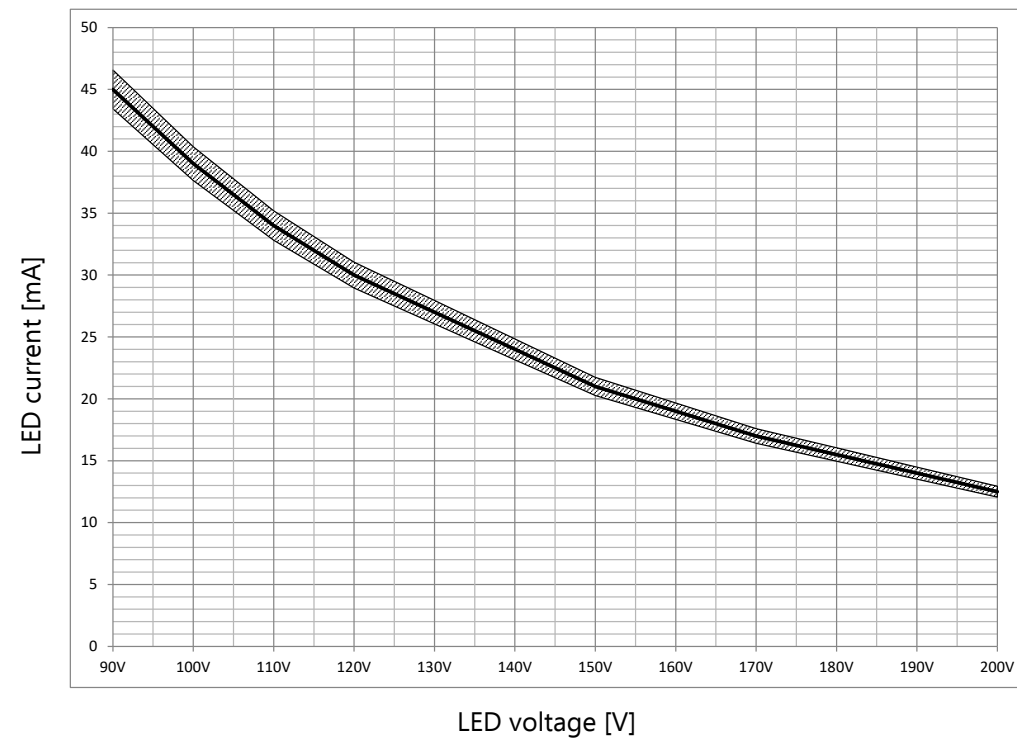

Document under development and product specifications may be subject to change without prior notice.

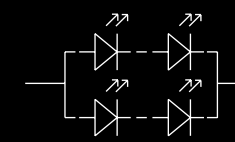

ACCESSORY | LITHIUM IRON PHOSPATE (LiFePO4) BATTERIES

Applicable LiFePO4 battery packs to Omni-LED models (Available as module and battery kits or remote box solutions only)

		Battery Options									
		1 x 22650	2 x 22650 Stick	1 x 26650	2 x 22650 Pack	3 x 18650 Stick	2 x 22650 Stick	2 x 26650 Stick	3 x 22650 Stick	3 x 26650 Stick	12 x 18650 Pack
Model Number		LFP3.2V/2.2Ah	LFP3.2V/4.4Ah/SS	LFP3.2V/3.6Ah	LFP3.2V/4.4Ah/PS	LFP3.2V/4.5Ah/SS	LFP6.4V/2.2Ah/SS	LFP6.4V/3.6Ah/SS	LFP9.6V/2.2Ah/SS	LFP9.6V/3.6Ah/SS	LFP9.6V/6Ah/QS
OL55/3W/M3/LFP	1 hour	✓									
	3 hours		✓		✓	✓					
OL55/4W/M3/LFP	1 hour						✓				
	3 hours							✓			
OL80/2W/M3/LFP	1 hour	✓									
	3 hours			✓							
OL90/4W/M3/LFP	1 hour						✓				
	3 hours							✓			
OL200/4W/M3/LFP	1 hour						✓				
	3 hours							✓			
OL230/4W/M3/LFP	1 hour					✓					
	3 hours								✓		
OL230/8W/M3/LFP	1 hour								✓		
	3 hours									✓	
OL230/12W/M3/LFP	1 hour									✓	
	3 hours										✓

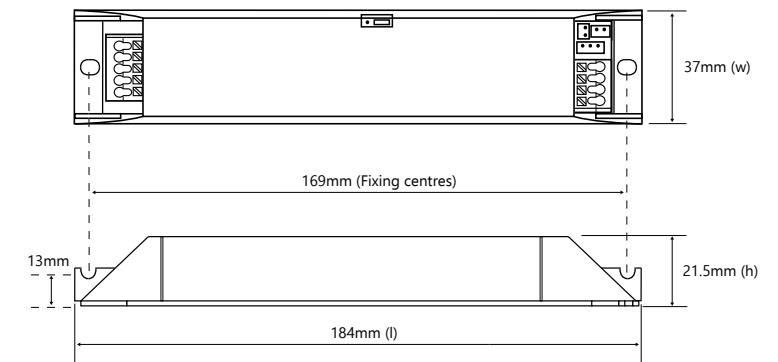

Document under development and product specifications may be subject to change without prior notice.